

DIGITAL MIXER AMPLIFIER

A-3224D-AS 1/A-3248D-AS 1
A-3212DM-AS 1/A-3224DM-AS 1/A-3248DM-AS 1
A-3212DMZ-AS 1/A-3224DMZ-AS 1/A-3248DMZ-AS 1
A-3248DME-AS 1

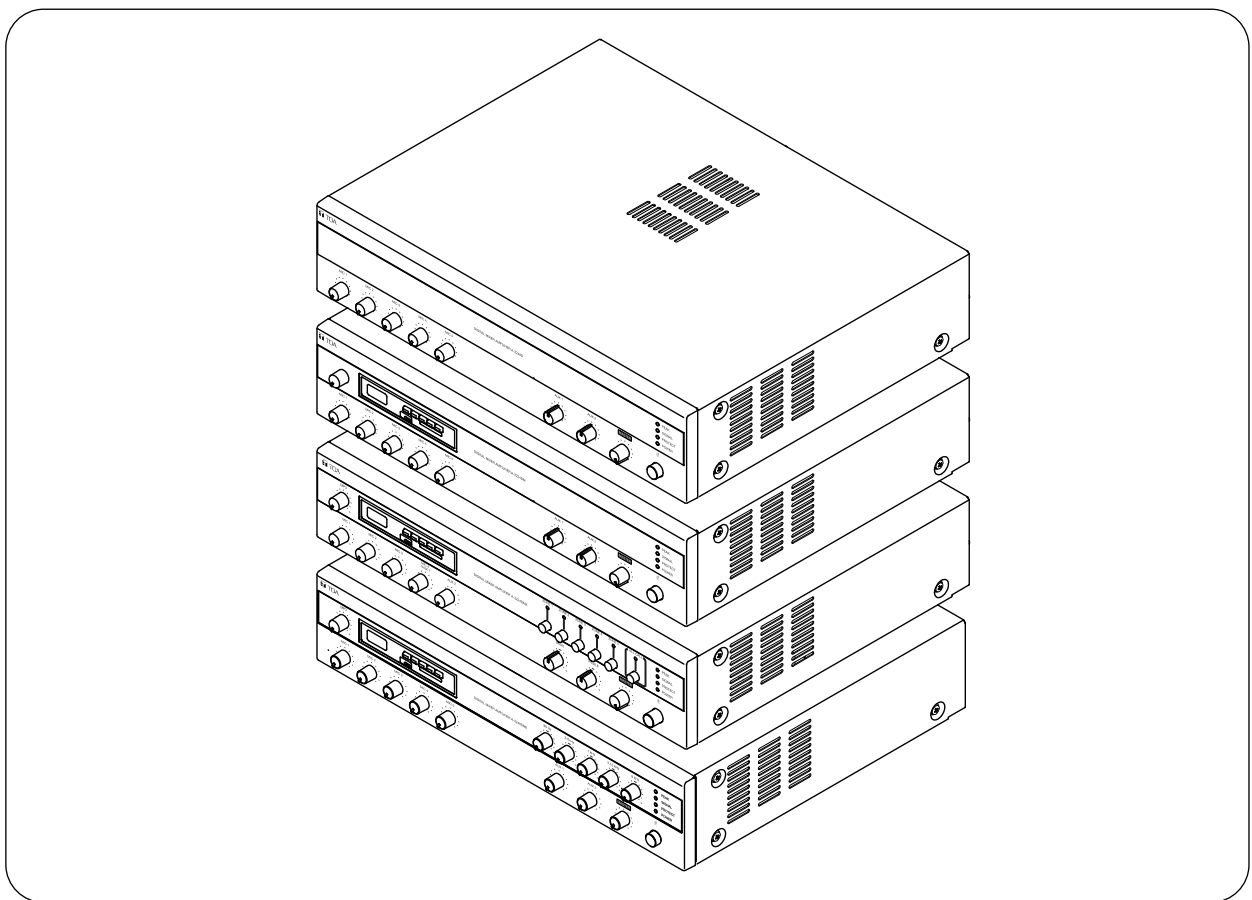

TABLE OF CONTENTS

1. SAFETY PRECAUTIONS	2	7.2. Speaker Connections	9
2. GENERAL DESCRIPTION	3	7.3. Example of External Equipment	
3. FEATURES	3	Connections	9
4. NOMENCLATURES AND FUNCTIONS...	4	8. BLOCK AND LEVEL DIAGRAMS	11
5. ABOUT OPERATING MP3	7	9. DIMENSIONAL DIAGRAM	13
6. MUTING FUNCTION	8	10. SPECIFICATIONS	14
7. CONNECTIONS			
7.1. Input Connections	8		

Thank you for purchasing TOA's Digital Mixer Amplifiers.
 Please carefully follow the instructions in this manual to ensure long, trouble-free use of your equipment.

1. SAFETY PRECAUTIONS

- Before installation or use, be sure to carefully read all the instructions in this section for correct and safe operation.
- Be sure to follow all the precautionary instructions in this section, which contain important warnings and/or cautions regarding safety.
- After reading, keep this manual handy for future reference.

Safety Symbol and Message Conventions

Safety symbols and messages described below are used in this manual to prevent bodily injury and property damage which could result from mishandling. Before operating your product, read this manual first and understand the safety symbols and messages so you are thoroughly aware of the potential safety hazards.

WARNING

Indicates a potentially hazardous situation which, if mishandled, could result in death or serious personal injury.

CAUTION

Indicates a potentially hazardous situation which, if mishandled, could result in moderate or minor personal injury, and/or property damage.

WARNING

When Installing The Unit

- Do not expose the unit to rain or an environment where it may be splashed by water or other liquids, as doing so may result in fire or electric shock.
- Use the unit only with the voltage specified on the unit. Using a voltage higher than that which is specified may result in fire or electric shock.
- Do not cut, kink, otherwise damage nor modify the power supply cord. In addition, avoid using the power cord in close proximity to heaters, and never place heavy objects including the unit itself on the power cord, as doing so may result in fire or electric shock.
- The terminals marked with the symbol  are hazardous live. The external wiring to these terminals requires installation by an instructed person.
- The socket-outlet shall be installed near the equipment and the plug (disconnecting device) shall be easily accessible.
- Be sure to replace the unit's terminal cover after connection completion. Because the voltage of up to 100V is applied to the high impedance speaker terminals, never touch these terminals to avoid electric shock.
- Be sure to ground to the safety ground (earth) terminal to avoid electric shock. Never ground to a gas pipe as a catastrophic disaster may result.

When The Unit is in Use

- Should the following irregularity be found during use, immediately switch off the power, disconnect the power supply plug from the AC outlet and contact your nearest TOA dealer. Make no further attempt to operate the unit in this condition as this may cause fire or electric shock.
 - If you detect smoke or a strange smell coming from the unit.
 - If water or any metallic object gets into the unit.
 - If the unit falls, or the unit case breaks.
 - If the power supply cord is damaged (exposure of the core, disconnection, etc.)
 - If it is malfunctioning (no tone sounds.)
- To prevent a fire or electric shock, never open nor remove the unit case as there are high voltage components inside the unit. Refer all servicing to your nearest TOA dealer.
- Do not place cups, bowls, or other containers of liquid or metallic objects on top of the unit. If they accidentally spill into the unit, this may cause a fire or electric shock.
- Do not insert nor drop metallic object or flammable materials in the ventilation slots of the unit's cover, as this may result in fire or electric shock.

CAUTION

When Installing The Unit

- Never plug in nor remove the power supply plug with wet hands, as doing so may cause electric shock.
 - When unplugging the power supply cord, be sure to grasp the power supply plug, never pull on the cord itself. Operating the unit with a damaged power supply cord may cause a fire or electric shock.
 - When moving the unit, be sure to remove its power supply cord from the wall outlet. Moving the unit with the power cord connected to the outlet may cause damage to the power cord, resulting in fire or electric shock. When removing the power cord, be sure to hold its plug to pull.
 - Do not block the upper panel ventilation slots in the unit's cover. Doing so may cause heat to build up inside the unit and result in fire.
- Avoid installing the unit in humid or dusty location, in location exposed to direct sunlight, near the heaters, or in location generating sooty smoke or steam. As doing otherwise may result in fire or electric shock.
 - Keep the distance for all side of units 10 cm away from the object that may obstruct air flow for internal units temperature rise prevention.

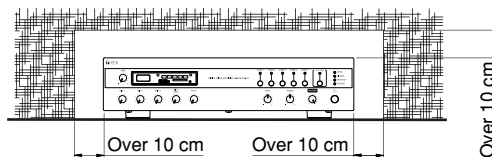

When The Unit is In Use

- Do not place heavy object on the unit as this may cause it to fall or break which may result in personal injury and/or property damage. In addition, the object itself may fall off and cause injury and/or damage.

2. GENERAL DESCRIPTION

TOA's Digital Mixer Amplifier A-3000D-AS series, A-3000DM-AS series, A-3000DMZ-AS series and A-3248DME-AS are high performance mixer power amplifier suited for broadcasting paging or background music in schools, offices, shops, factories, mosques, churches and large rooms.

3. FEATURES

- High durability, high reliability and high performance.
- Four (Five microphone on A-3248DME-AS) microphone inputs, two AUX inputs and one recording output.
- Speaker output of constant voltage distribution system (100V) & low impedance (4Ω).
- Operates on AC power.
- Muting function.
- Independent input volume control and master volume control.
- Independent tone control of boost and cut type for both high and low frequency.
- MIC 1 equipped with phantom power for condenser microphone and also option for Chime Microphone.
- Current limiter circuitry protects transistor and thermal protection circuitry prevent a failure due to overheat.
- All MIC inputs are electronically-balanced input.
- Additional features such as built in MP3 Player, Zone Selector and 5 Bands Equalizer

4. NOMENCLATURES AND FUNCTIONS

For A-3000D-AS Series, A-3000DM-AS Series & A-3000DMZ-AS Series

[Front Panel]

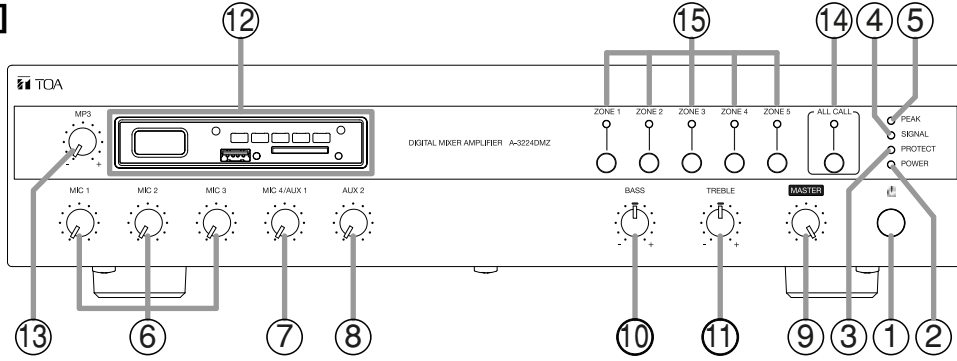

[Rear Panel]

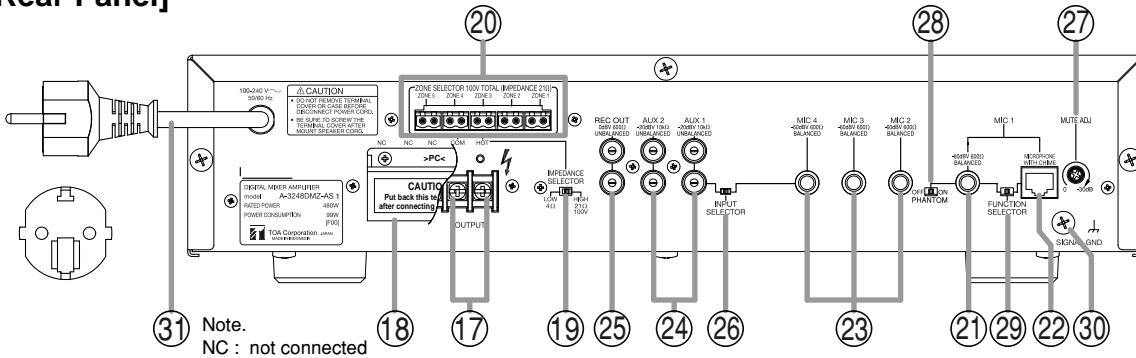

For A-3248DME-AS

[Front Panel]

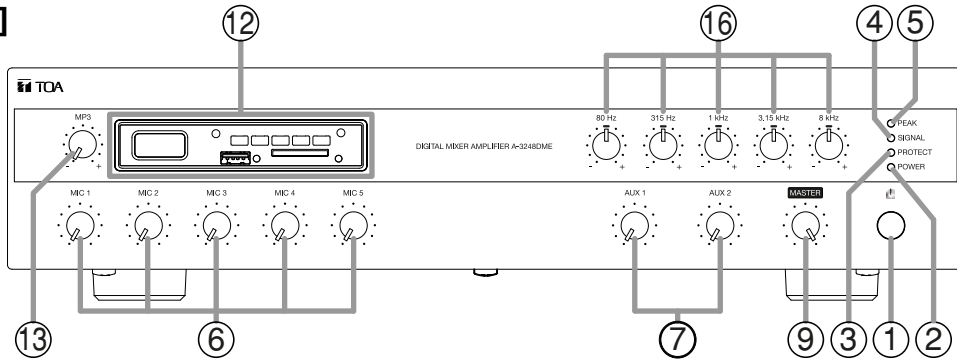

[Rear Panel]

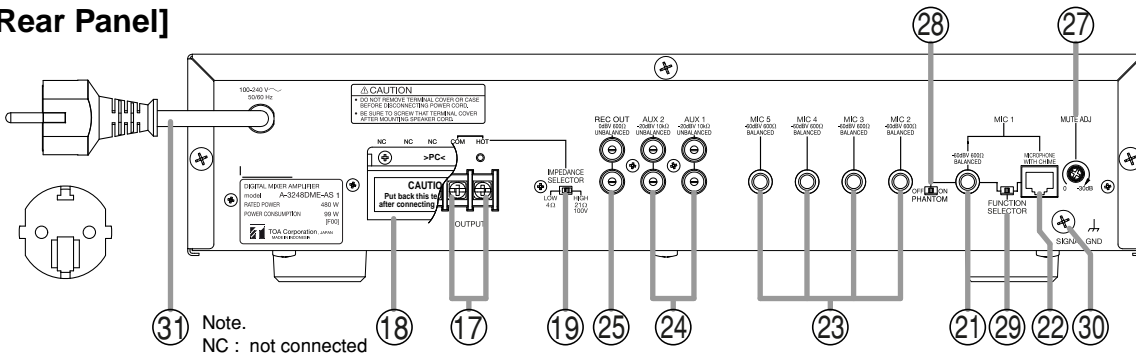

1. Power Switch

Press to turn ON the power.
Press again to turn off the power.

2. Power Indicator

Lights green when power is switched on.

3. Protect Indicator

Lights when protect function activated.

4. Signal Indicator

Lights green for indicates present of an output signal.

5. Peak Indicator

Lights red to indicate the output signal reaches the peak level, this indicates that sound is distorted. In such case, adjust each volume control to reduce output level.

- 6. Volume Control for MIC**
Adjust the microphone level.
- 7. Volume Control for MIC 4/AUX 1**
Adjust level for MIC 4/AUX 1 whichever activated, see number 26. Not available for A-3248DME-AS.
- 8. Volume Control for AUX**
Adjust the AUX level.
- 9. Master Volume Control**
Adjust overall signal level.
- 10. Bass Control**
Rotate each knob clockwise to increase bass frequency response and counter clockwise to reduce it. Center position give flat characteristic.
- 11. Treble Control**
Rotate each knob clockwise to increase treble frequency response and counter clockwise to reduce it. Center position give flat characteristic.
- 12. MP3 Panel**
Built-in MP3 feature. Not available for model A-3224D-AS & A-3248D-AS.
For detail of MP3 panel, please see page 6.
- 13. MP3 Volume Control**
Adjust the MP3 level. Not available for model A-3224D-AS & A-3248D-AS.
- 14. All Call Knob**
Push the knob to activated all zone terminals. Available only for A-3212DMZ-AS, A-3224DMZ-AS and A-3248DMZ-AS.
- 15. Zone Selector Knob**
Push the knob to activated each correspondent zone terminal. Available only for A-3212DMZ-AS, A-3224DMZ-AS and A-3248DMZ-AS.
- 16. 5 Bands Equalizer**
Rotate each knob clockwise to increase correspondent frequency response and counter clockwise to reduce it. Center position give flat characteristic. Available for A-3248DME-AS model.
- 17. Output Terminal**
Terminal for connecting speaker. Use only with high impedance speaker.
- 18. Terminal Cover**
To avoid electric shock by high voltage from output terminal, put back terminal cover after connecting speaker cords.
- 19. Impedance Selector**
Selecting to 100 V for using high impedance type of loudspeaker connection or 4 Ω for low impedance application.
Factory preset : 100 V
- 20. Zone Selector Terminal**
Terminal for zone selector (high impedance). Available only for A-3212DMZ-AS, A-3224DMZ-AS and A-3248DMZ-AS.
- 21. MIC 1 Input Terminal**
−60 dB (1 mV), 600 Ω, electronically balanced. For phantom microphone type, see number 28. Phone plug uses double pole type, but also can use single pole type.
- 22. MIC 1 Input Terminal for Chime Microphone**
Use this terminal for connection of Chime microphone (using RJ45 Plug)
- 23. MIC 2 - 5 Input Terminals**
−60 dB (1 mV), 600 Ω, electronically balanced. Because microphone input is balanced type, phone plug uses double pole type, but also can use even single pole type.
Mic 5 available for A-3248DME-AS model only.
- 24. AUX 1 & AUX 2 Input Terminal**
−20 dB, 10 kΩ, unbalanced. Monaural RCA pin jack. Accept external equipment output signal.
- 25. Recording Output**
0 dB (1 V), 600 Ω, unbalanced. Output all input signal before the master volume control. Connect to a cassette deck, etc when recording the broadcast content.
- 26. Input Selector**
Selecting to MIC 4 for using balanced −60 dB 600 Ω input, or selecting to AUX 1 for unbalanced −20 dB 10 kΩ input. Not available for A-3248DME-AS model.
Factory preset : AUX 1
- 27. Muting Level Control**
Adjust attenuating level from 0 to −30 dB.
Factory preset : −30 dB (maximum muting level).
- 28. Phantom Switch**
Selecting to ON position supplies power for condenser microphone from MIC 1. Be sure to select OFF when using the microphone that can not operated on phantom power. The phantom power is 21 V DC.
Factory preset : OFF
- 29. Function Switch**
Selecting to left for using balanced connection −60 dB 600 Ω input (phone jack), or selecting to right for using chime microphone input (RJ45).
Factory preset : left (phone jack).
- 30. Ground Terminal**
Connect to ground (earth) to avoid electric shock.
- 31. AC Power Cord**
Connect to an AC power source.

[MP3 Panel]

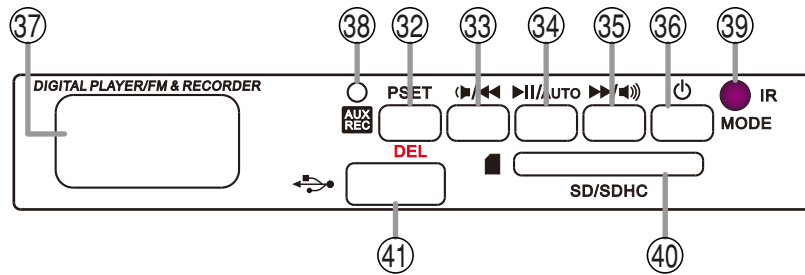

32. AUX REC/PSET

In Aux mode, pressing this button will record to SD card. If SD card is not inserted to the slot, the unit will record to inserted USB. If pressing this button while recording, the unit will stop recording, and track that was being recorded will be saved in the last space of the folder. LED is turned ON when recording begins and will OFF when recording ends (on Panel MP3). Display text appear "REC" and time. In FM mode, pressing this button enter the station saving mode. Then press play to save the current frequency as a station. In MP3 mode, press this button to choose the track that the user wants to delete and then pressing it for 3 seconds to actually delete the track. Text appear "DEL".

33. Volume Decrease/Skip to Last Track

Keep pressing this button will decrease the volume (display: U32→U00). In MP3 mode, pressing this button will skip to the last track. In FM mode, pressing this button will tune downwards in frequency with each segment of 50 kHz. Pressing this button for 3 seconds will search stations downwards in frequency and the search will automatically stop at the frequency where there is station available.

34. Play/Pause

In MP3 mode, pressing this button, PLAY will switch to PAUSE. Pressing again PAUSE will switch to PLAY. Display ►► will appear, and time indicator blinking. If the unit has been STOPPED, it will switch to PLAY. In FM mode, pressing this button will skip to the channel Frequency has been saved. In FM mode, pressing this button for 3 seconds will automatically search and save available station in a maximum number of 30 station. Display CH01, CH02, ...CH30.

35. Volume Increase/Skip to Next Track

Keep pressing this button will increase the volume (display: U00→U32). In MP3 mode, pressing this button will skip to the next track. In FM mode, pressing this button will tune upwards in frequency with each segment of 50 kHz. Pressing this button for 3 seconds will search stations upwards in frequency and the search will automatically stop at the frequency where there is station available.

36. Mode

When the unit is turned ON, pressing this button for 3 seconds will turn off the unit. When the unit is turned OFF, pressing this button will turn on the unit. Display will play to the last mode. When the unit is turned ON, pressing this button will switch between the modes. Display text will appear "AUX → FM → USB → SD → BT".

37. Display Indicator

Indicator 188:88. This indicator illuminates by counting/increasing when operating MP3 Player
 *For volume displayed (U-00 → U-32) with +/- 1
 *For FM Radio in increase - decrease vol mode is displayed (87.50 → 108.00)with +/- 50 kHz
 *For FM Radio in play/pause mode can be saved and displayed (CH01 → CH30)

USB Indicator : when USB connected this indicator lights up and blinking on the display, file is ready to operate.

SD Indicator : when SD connected this indicator lights up and blinking on the display, file is ready to operate.

FM Indicator : when FM mode selected or when its turned on this indicator lights up and blinking on the display, file is ready to operate.

BT Indicator : when connected / pairing this indicator lights up with blinking on the display, file is ready to operate.

► **Play Indicator** : in MP3 mode, illuminated with blinking display, indicating operated PLAY.

►► **Pause Indicator** : in MP3 mode, illuminated with blinking display, indicating operated PAUSE.

AUX Indicator : when AUX mode selected, input from AUX & MIC connected to MP3

REC Indicator : AUX mode selected, then press PSET then start recording. In display, this indicator blink and result saved to installed USD or SD.

38. AUX REC Indication

Lights when playing recording result.

39. IR Receiver

Signal receiver from optional remote control.

40. SD Card Input













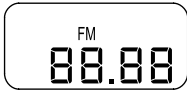

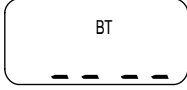



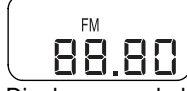

Socket for SD Card Input



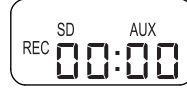

41. USB Card Input

Socket for USB Input.

Note : -not recommended for charging

5. ABOUT OPERATING MP3

MP3 Player	Operating Mode	Indication
	<p>- Press button MODE while USB & SD install "AUX→FM→USB→SD→BT".</p>	<p>a. USB & SD install</p> <p>1.  Display mode AUX</p> <p>2.  Display mode FM ↓</p> <p>3.  Display mode USB ↓</p> <p>4.  Display mode SD</p> <p>5.  Display mode Bluetooth</p>
	<p>* MP3 Mode (USB or SD)</p> <ul style="list-style-type: none"> - Playing normal condition. - Press button ▶ will pause. - Press button ▶ again will normal play. <p>* FM Mode</p> <ul style="list-style-type: none"> - Playing normal condition. - Press button ▶ will change next channel. <p>- Press the button 3 seconds will automatically search and save channel from CH01 until CH30 after completion will play in CH01.</p>	<p>USB install</p> <p>1.  Display normal play</p> <p>2.  Display blinking</p> <p>FM Mode</p> <p>1.  Display normal play</p> <p>2.  Change next channel</p> <p>FM Mode</p> <p>1.  Display normal play</p> <p>2.  Search and save from CH02 ↓</p> <p>3.  Until CH30</p> <p>4.  Beginning play in CH01</p>
	<p>* MP3 Mode (USB or SD)</p> <ul style="list-style-type: none"> - Press button MODE (display AUX) and then press button AUX REC (will save input from AUX IN, WIRED MIC, WIRELESS MIC at SD as first priority and then USB card and volume control is made Max). - View second will be record Display text appear " rEC " and time. - Press button ▶ to hold, press again ▶ will continue to Record. (for prepared recording). - Press button AUX REC again will stop, and will be saved in the last space of the folder. 	<p>AUX Mode and insert SD card</p> <p>1.  Display AUX mode</p> <p>2.  Press AUX REC ↓</p> <p>3.  Record start at SD ↓</p> <p>4.  Time indication blinking</p> <p>5.  Record start at SD</p> <p>6.  Display AUX mode</p>

MP3 Player	Operating Mode	Indication
	<p>* FM Mode</p> <ul style="list-style-type: none"> - Press button AUX REC enter the station saving mode. - Press PLAY to save the current frequency as a station - Press button AUX REC for 3 sec to actually save this frequency to this position. 	<p>FM Mode</p> <p>1.  Display normal play</p> <p>2.  CH initial frequency ↓</p> <p>FM Mode</p> <p>4.  Display normal play</p> <p>3.  If Select no 9, frequency CH09 same with CH02</p>

6. MUTING FUNCTION

MIC 1 has a priority function. When MIC 1 input is used it take precedence and automatically attenuate the volume of MIC 2, MIC 3, MIC 4, MIC 5, AUX 1 & AUX 2 inputs by 0 up to 30 dB, which is adjustable with the MUTE ADJ on rear panel. The attenuation level is preset for -30 dB at the factory.

Remark : About mute function

- When signal of MIC 1 appear, mute circuit work promptly.
- When signal of MIC 1 disappear, it returns to it previous state about 3 seconds later.

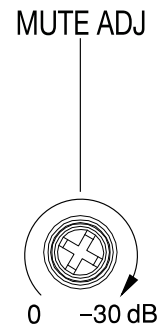

7. CONNECTIONS

7.1. Input Connections

- MIC 1 - 5 Connection (Phone Plug)

Because MIC input is electronically balanced type, it uses double pole phone plug.

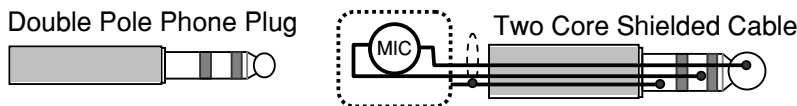

However, the microphone input circuit is in a condition of unbalance when using single pole type. Since the state of unbalance is more vulnerable for noise generation, the recommended length of microphone cable is at less than 10 meters.

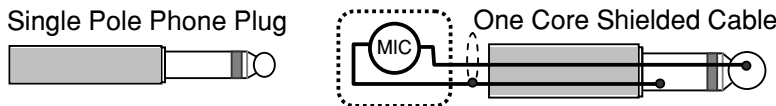

- AUX Input Connection (RCA Pin Jack)



- Chime Microphone Connection (Straight Ethernet Plug)

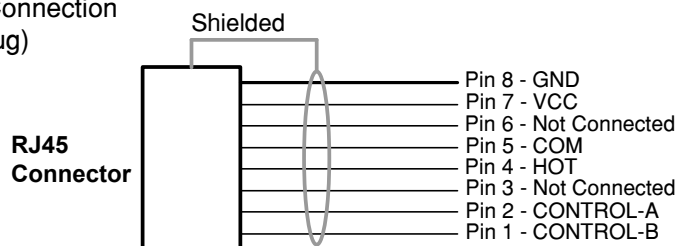

7.2. Speaker Connections

Impedances indicate at the terminal represent the total impedance (load) of the speaker system. Impedance can be switched from high impedance to low impedance (4 Ω)

Total impedance for 100 V line :

- 83 Ω (A-3212DM-AS, A-3212DMZ-AS)
- 42 Ω (A-3224D-AS, A-3224DM-AS, A-3224DMZ-AS)
- 21 Ω (A-3248D-AS, A-3248DM-AS, A-3248DMZ-AS, A-3248DME-AS)

• Using Screw Terminal

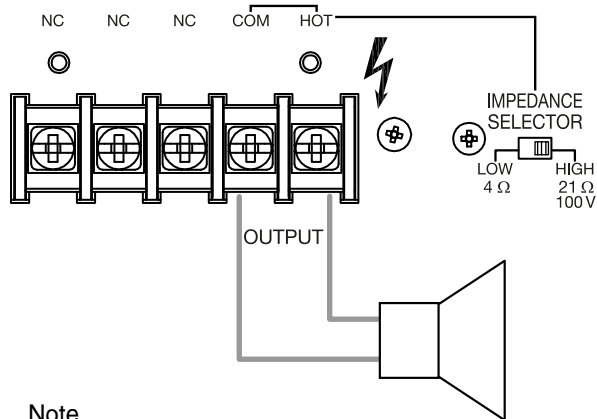

Note.
NC : not connected

• Using 5 Zones Selector Terminal

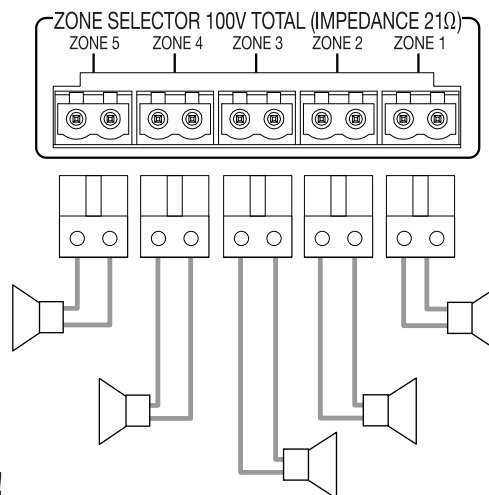

CAUTION !
Impedances indicate at the terminal represent the total impedance (load) of the speaker system.

7.3. Example of External Equipment Connections

Example of External Equipment Connections (4 mic input)

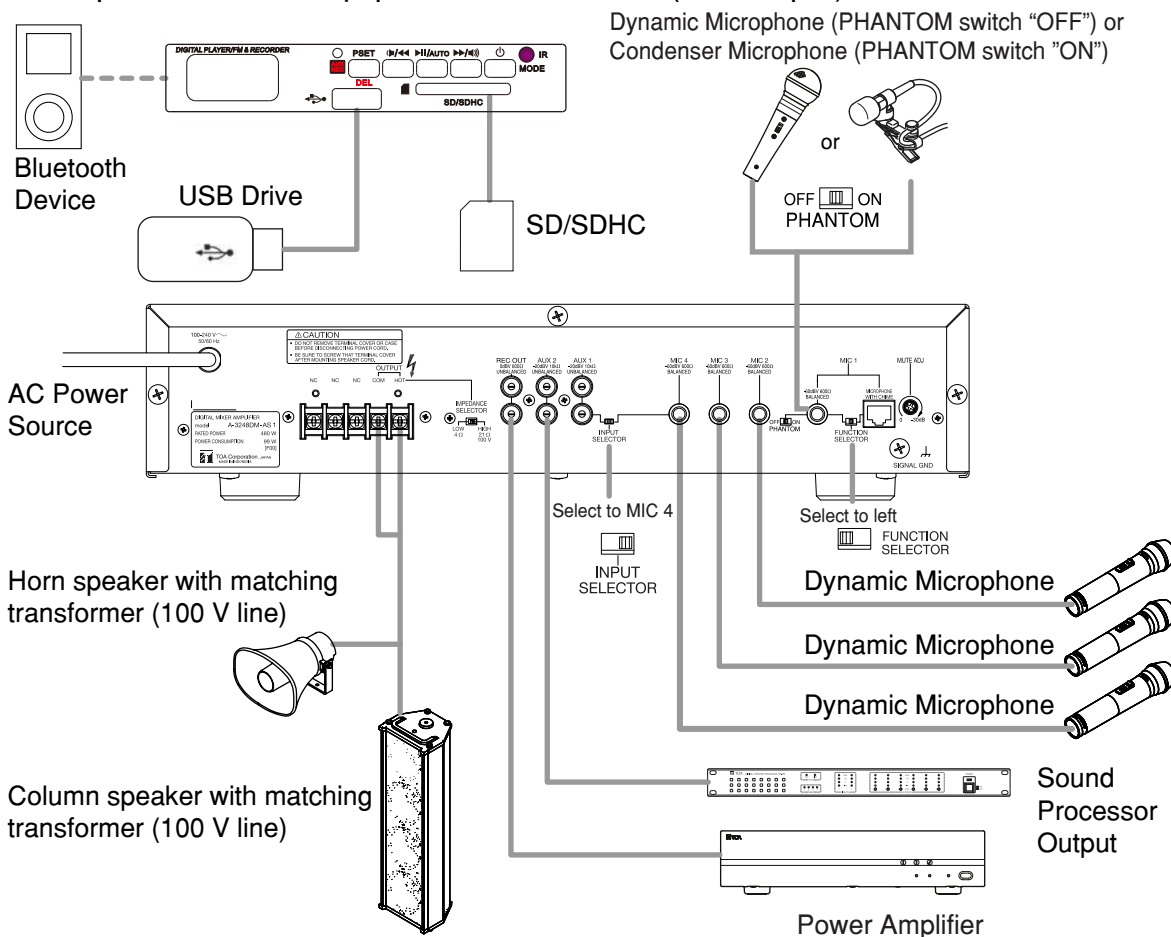

Example of External Equipment Connections (5 zone selector , 3 mic input)

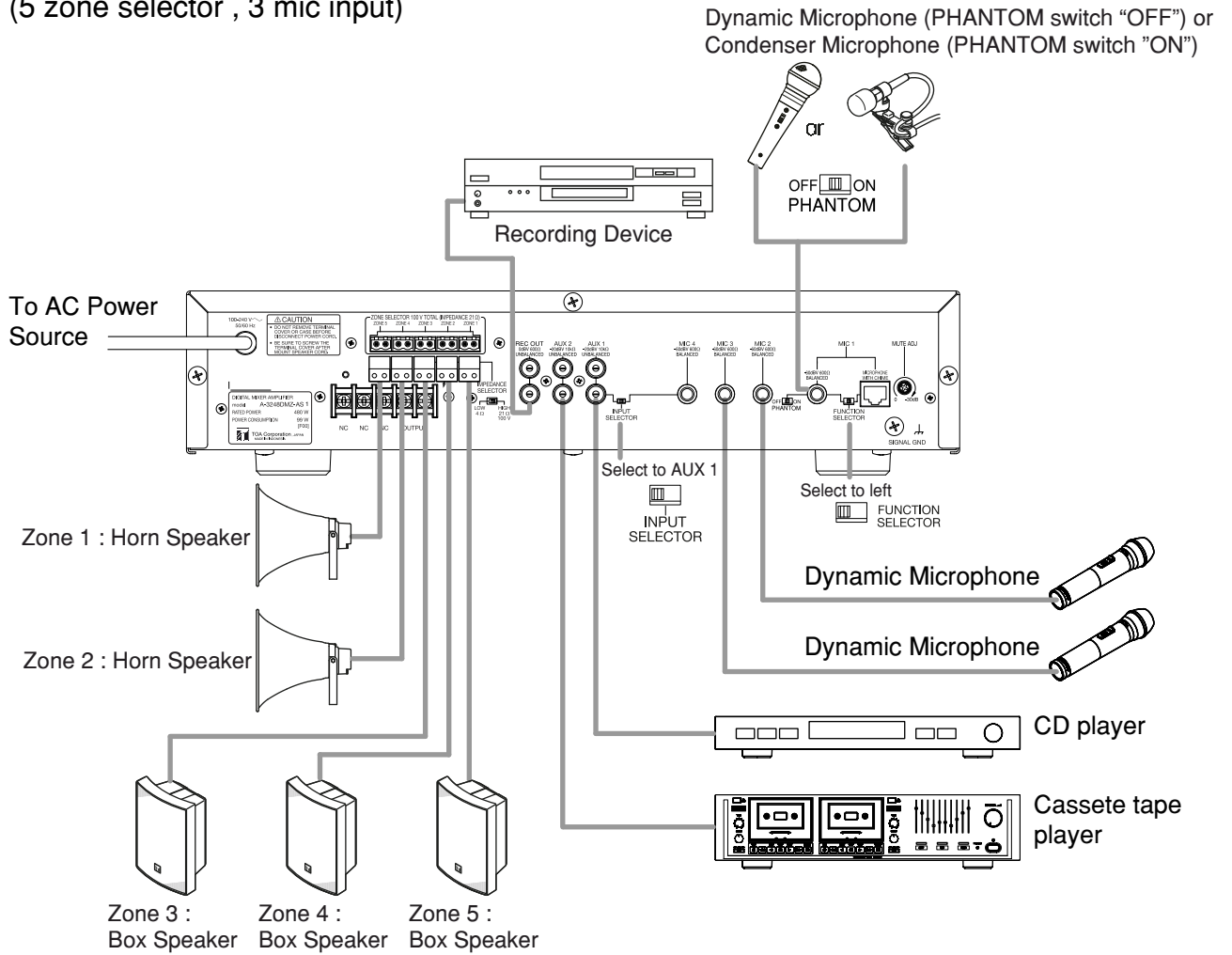

Example of External Equipment Connections (model with 5 band equalizer, 1 chime microphone, 4 microphone input, 2 aux, 1 rec out)

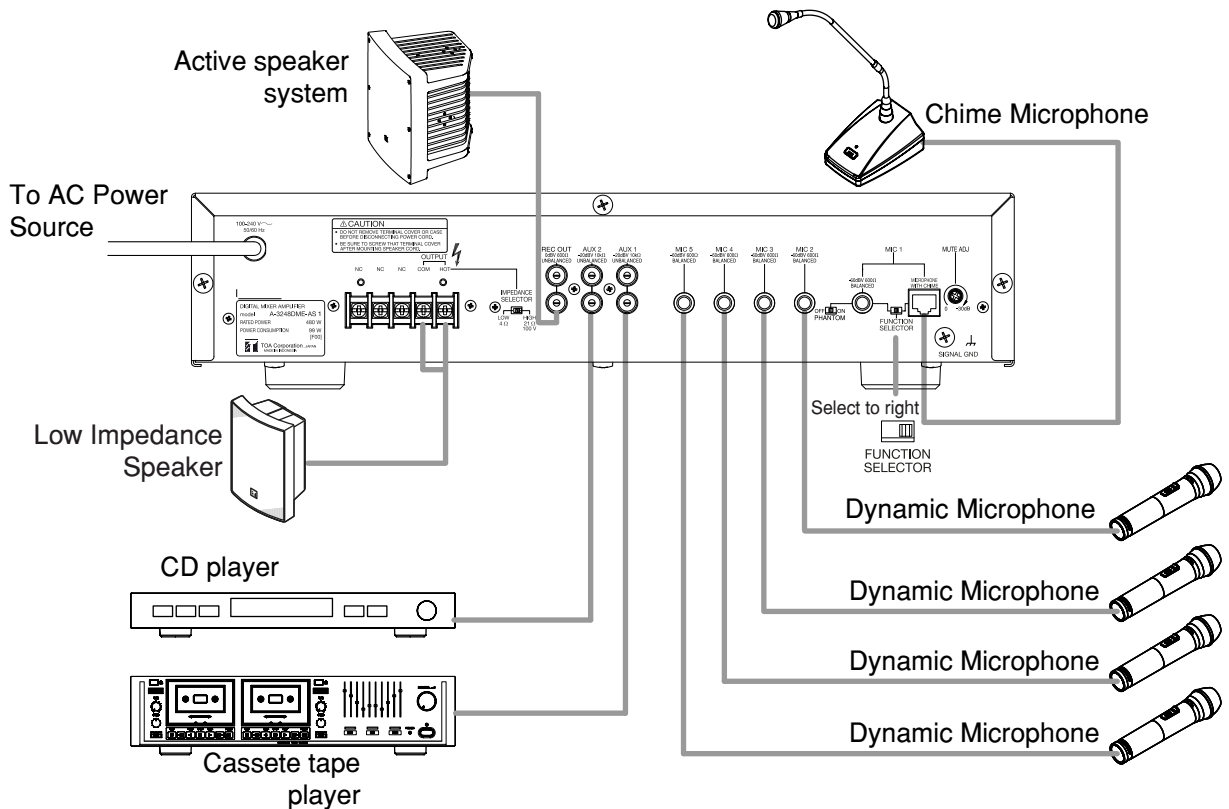

8. BLOCK AND LEVEL DIAGRAMS

[A-3000D Series, A-3000DM Series, A-3000DMZ-Series]

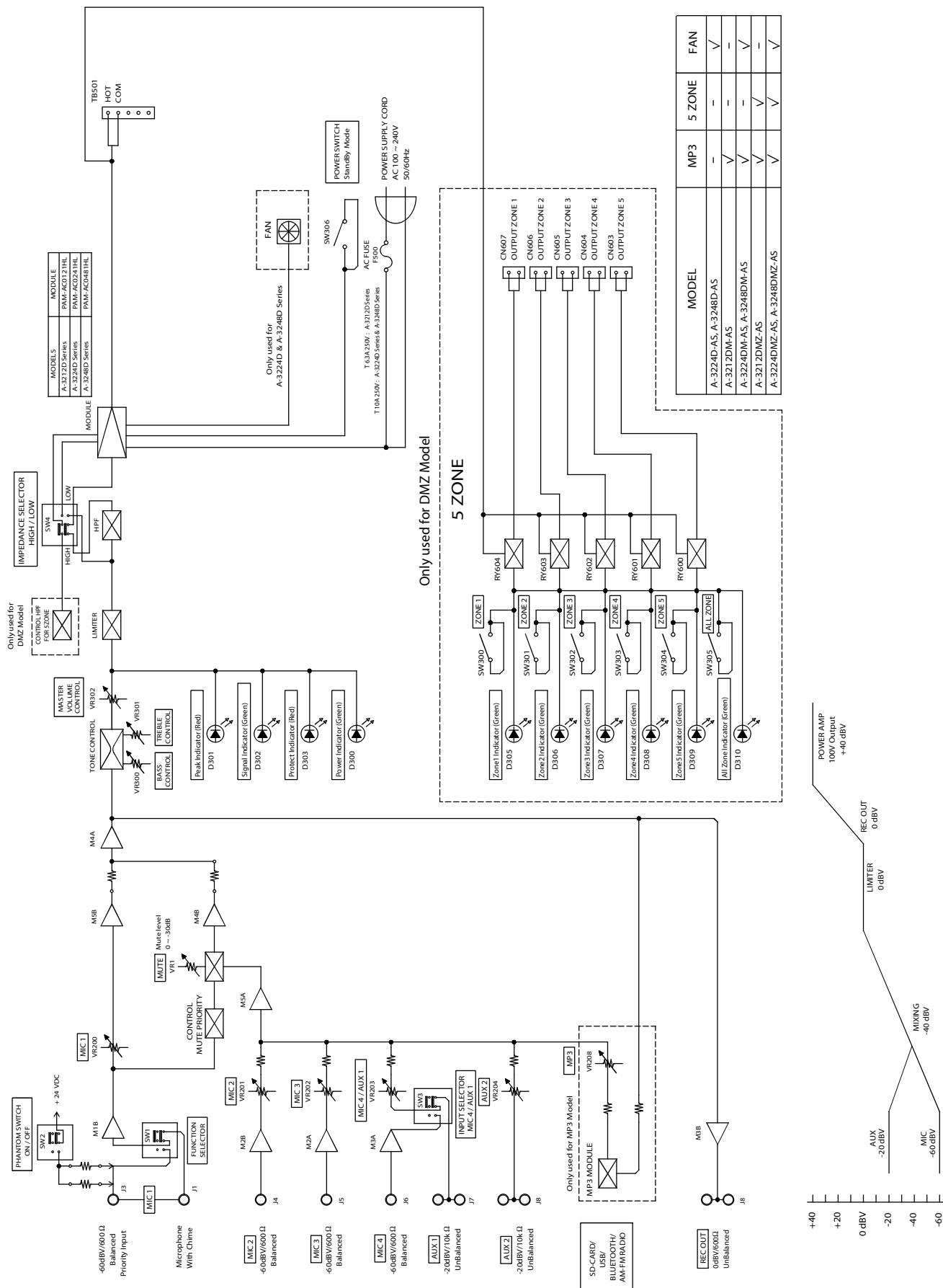

[A-3248DME-AS]

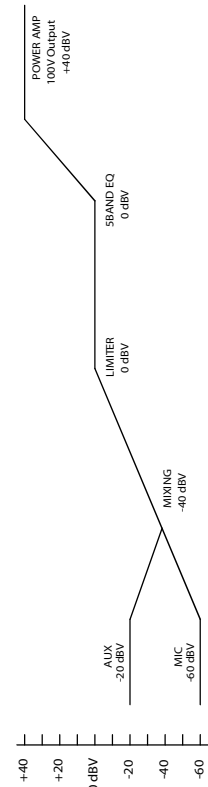
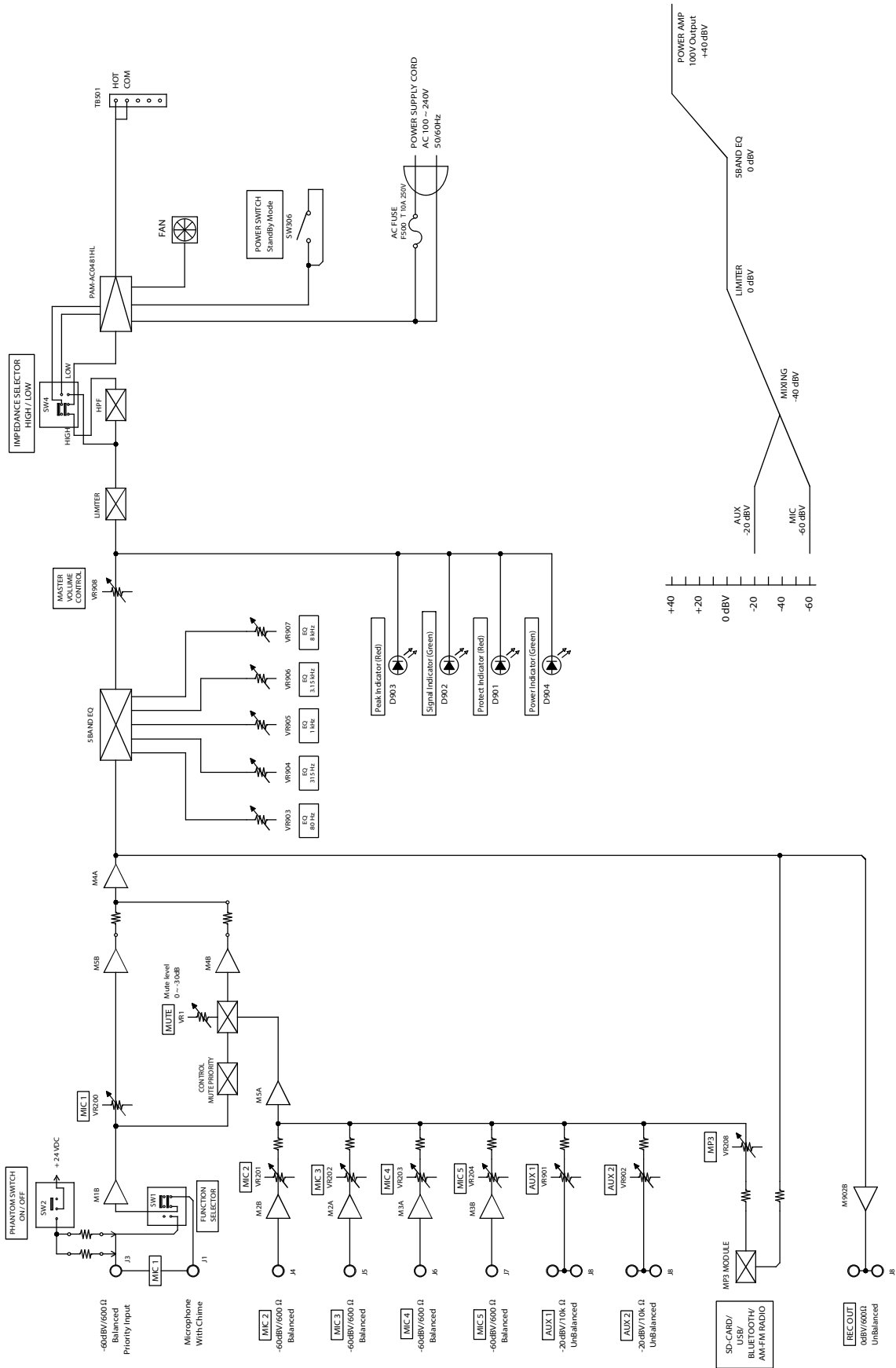

9. DIMENSIONAL DIAGRAM

Dimensional diagram represent by A-3248DMZ-AS image. Outer dimension for all series are same.

Units : mm (inches)

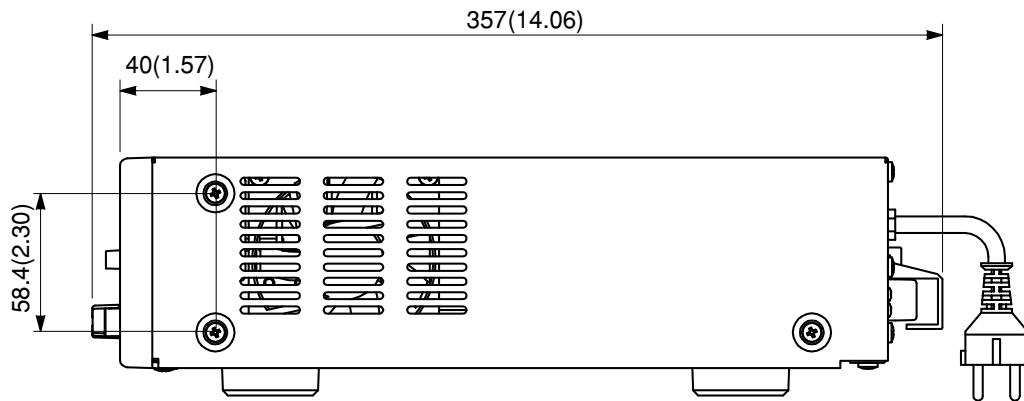
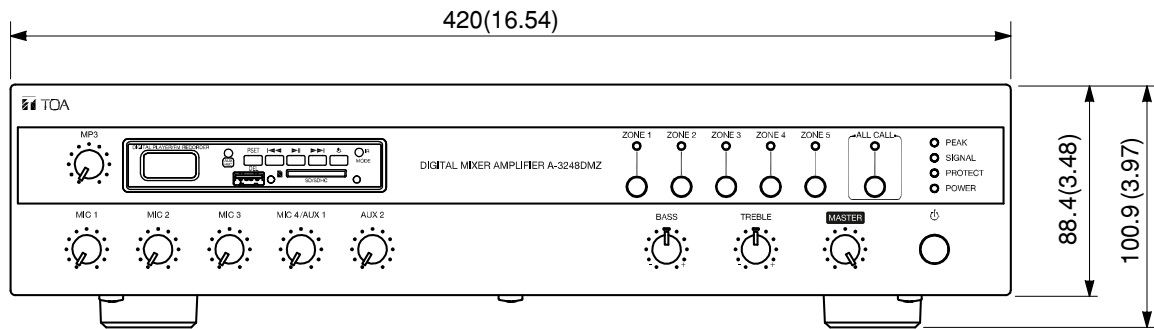

10. SPECIFICATIONS

A-3000D-AS 1 Series, A-3000DM-AS 1 Series

Model no.	A-3224D-AS 1	A-3248D-AS 1	A-3212DM-AS 1	A-3224DM-AS 1	A-3248DM-AS 1	
Power Source	100 - 240 V AC~ 50/60 Hz					
Power Consumption (EN 60065)	62 W	99 W	44 W	62 W	99 W	
Rated Output	240 W	480 W	120 W	240 W	480 W	
Input	MIC 1	-60 dB*, 600 Ω, Balanced, Phone Jack, selectable to RJ45				
	MIC 2 - 3	-60 dB*, 600 Ω, Balanced, Phone Jack				
	MIC 4	-60 dB*, 600 Ω, Balanced, Phone Jack, selectable to AUX 1				
	AUX 1	-20 dB*, 10 kΩ, Unbalanced, RCA pin jack, selectable to MIC 4				
	AUX 2	-20 dB*, 10 kΩ, Unbalanced, RCA pin jack				
	MP3	-	LED Display, support USB, SD/MMC card (up to 32 GB), bluetooth, radio FM, record			
Output	Speaker Out	Speaker output in screw type terminal				
	Direct Line (selectable)	42 Ω (100 V)	21 Ω (100 V)	83 Ω (100 V)	42 Ω (100 V)	21 Ω (100 V)
		4 Ω				
Rec Out	0 dB*, 600 Ω, Unbalanced, RCA pin jack					
Phantom Power	DC +21 V (MIC 1)					
S/N Ratio	Over 60 dB					
Total Harmonic Distortion	Under 1% at 1 kHz, 1/3 rated power					
Muting	Mic 1 : Mute other input signals by 0 - 30 dB attenuation					
Frequency Response	50 - 20000 Hz					
Tone Control	Bass: ± 10 dB at 100 Hz Treble: ± 10 dB at 10 kHz					
Indicator	POWER, SIGNAL, PEAK, PROTECT					
Operating Temperature	0 °C to +40 °C					
Ventilation	Fan Cooling		Natural Air Cooling	Fan Cooling		
Finish	Panel : ABS Resin, Black Case : Steel Plate, Black					
Dimensions	420 (W) x 100.9 (H) x 357 (D) mm (16.54" x 3.97" x 14.06")					
Weight	4.9 kg (10.80 lb)	5.0 kg (11.02 lb)	4.6 kg (10.14 lb)	4.9 kg (10.80 lb)	5.0 kg (11.02 lb)	

* 0 dB = 1 V

Note : Design and specification are subject to change without prior notice for improvement.

A-3000DMZ-AS 1 Series, A-3248DME-AS 1

Model no.	A-3212DMZ-AS 1	A-3224DMZ-AS 1	A-3248DMZ-AS 1	A-3248DME-AS 1	
Power Source	100 - 240 V AC~ 50/60 Hz				
Power Consumption (EN 60065)	44 W	62 W	99 W	99 W	
Rated Output	120 W	240 W	480 W	480 W	
Input	MIC 1	-60 dB*, 600 Ω, Balanced, Phone Jack, selectable to RJ45			
	MIC 2 - 3	-60 dB*, 600 Ω, Balanced, Phone Jack		-60 dB, 600 Ω, Balanced, Phone Jack	
	MIC 4	-60 dB*, 600 Ω, Balanced, Phone Jack, selectable to AUX 1			
	MIC 5	-			
	AUX 1	-20 dB*, 10 kΩ, Unbalanced, RCA pin jack, selectable to MIC 4		-20 dB, 10 kΩ, Unbalanced, RCA pin jack	
	AUX 2	-20 dB*, 10 kΩ, Unbalanced, RCA pin jack			
	MP3	LED Display, support USB, SD/MMC card (up to 32 GB), bluetooth, radio FM, record			
Output	Speaker out	Speaker output in screw type terminal			
	Direct Line (selectable)	83 Ω (100 V)	42 Ω (100 V)	21 Ω (100 V)	21 Ω (100 V)
		4 Ω			
	Zone Selection	5 zone selector (all zones simultaneously selectable)			-
Rec Out	0 dB*, 600 Ω, Unbalanced, RCA pin jack				
Phantom Power	DC +21 V (MIC 1)				
S/N Ratio	Over 60 dB				
Total Harmonic Distortion	Under 1% at 1 kHz, 1/3 rated power				
Muting	Mic 1 : Mute other input signals by 0 - 30 dB attenuation				
Frequency Response	50 - 20000 Hz				
Tone Control	Bass: ± 10 dB at 100 Hz Treble: ± 10 dB at 10 kHz			± 10 dB at 80 Hz, 315 Hz, 1 kHz, 3.15 kHz, 8 kHz	
Indicator	POWER, SIGNAL, PEAK, PROTECT				
Operating Temperature	0 °C to +40 °C				
Ventilation	Natural Air Cooling	Fan Cooling			
Finish	Panel : ABS Resin, Black Case : Steel Plate, Black				
Dimensions	420 (W) x 100.9 (H) x 357 (D) mm (16.54" x 3.97" x 14.06")				
Weight	4.6 kg (10.14 lb)	4.9 kg (10.80 lb)	5.0 kg (11.02 lb)	5.0 kg (11.02 lb)	
Accessory	Removable terminal plug (2 pins) 5			-	

* 0 dB = 1 V

Note : Design and specification are subject to change without prior notice for improvement.

